

Castlewood®

*Book of
Fine Carved Wood
Decoration and Components*



Design Enhancements



Castlewood®

Book of Fine Carved Wood Decoration
Volume X

Design Enhancements

This edition includes several new product offerings including X-Island End Panels, Contemporary Box Range Hoods, Cascade Range Hoods, Transitional Range Hoods, and extended height options on all curved hood configurations.

We are also delighted to announce that Castlewood is now a fully accredited 2020 manufacturer. Our 2020 design program is open and available to all 2020 subscribers.

The products depicted in this catalog are sanded and ready to finish. Some items are hand carved. All hand carved items are sealed to aid in finishing and to help prevent splitting and cracking.

All dimensional specification information can be found by visiting the castlewood.com website. A corresponding specification guide with line drawings is available by request. Available stock species include Alder, Birch, Cherry, Hickory, Maple, Red Oak, Rubberwood, and White Oak. Other hardwood species can be made available as special order.

Dealer inquiries are always welcome. New product configurations are being added regularly. Please visit castlewood.com for the latest updates and details.

Email inquiries to info@castlewood.com.

Table of Contents



Hardwood Range Hoods and Accessories

Traditional Chimney Hoods	2
Tall Traditional Chimney Hoods	3
Transitional Chimney Hoods	3
Cascade Chimney Hoods	4
Arched Chimney Hoods	5
Gourmet Chimney Hoods	6
Epicurean Chimney Hoods	7
Executive Chimney Hood	7
Shiplap Chimney Hoods	8
Shiplap Epicurean Chimney Hoods	9
XL Shiplap Chimney Hoods	10
Corbel Chimney Hoods	11
Island Chimney Hoods	12
Chimney Hood Fronts	13
Mantel Hoods	14
Connoisseur Mantel Hoods	15
Classic Mantel Hoods	16
Shiplap Boxed Hoods	17
Shiplap Mantel Hoods	17
Contemporary Box Hoods	18
2 Piece Box Hoods	19
Mantel Hood Fronts	20
Mantel Hood Pillars	21
Paint Grade Chimney Hoods	22
Paint Grade Chimney Hood Fronts	23
Range Hood Ventilation	24
Range Hood Corbels	25



Carved Collections

White Oak	26-27
Shiplap	28-29
Acanthus	30-31
Classic	32
Mission	33
Shaker	34
Woven	35
Traditional Scroll	36-37



Component Collections

Bar Brackets	38
Countertop Supports	39
Bun Feet	40
Pedestal Feet	41
Floating Shelves	42
Mantel Shelves	43
Island Posts	44
Jumbo Posts & Legs	45
Table Legs	46
Onlays	47
Crown Molding	48
Cabinet Trim	49
Carved Moldings	50
Ornaments	51
Rosettes	52
Valances	53
Wine Lattice	54
Stemware Rack	55
Island End Panels	56
X-Island End Panels	57
Vanity Base Assemblies	58
Vanities	59
Drawer Sides	60
Removable Access Option	61



Molding Options

Application Gallery

Quick-Ship Program

	62
	63
	64-65



www.castlewood.com

Design Enhancements





Chimney Range Hoods

Castlewood Traditional Chimney style Range Hoods will add a warm traditional ambiance to any design. Constructed of hardwood plywood and solid lumber, these hoods can be embellished to fit a variety of tastes. Custom heights and depths are available upon request.

Scan here to view this range hood's specifications.



SY-WCH Traditional Chimney Range Hood

Castlewood Traditional Chimney Style Range Hoods are available in 33-1/8", 39-1/8", 45-1/8", and 51-1/8" overall widths. Each standard configuration is designed to be used with 9' ceilings. Optional Custom Chimney Extensions are available for taller ceiling heights. Chimney extensions are separate pieces. For 8' ceilings, order your hood without the chimney extension. Removable upper access option is available with all models (see page 61).

Standard species include **Alder, Cherry, Hickory, Maple, Red Oak, Plain Sawn White Oak and Rift Cut White Oak.** *Design enhancements including Moldings, Overlays and Rosettes can be found throughout this catalog.*

Available accessories include Stainless Steel or Silver Metallic Steel liners, 300CFM, 400CFM, and 600CFM Broan Ventilation units, 350CFM, 500CFM, 620CFM, 900CFM and 1200CFM Ascension Ventilation units and recirculation kits.

www.castlewood.com

Design Enhancements



Chimney Range Hoods

Castlewood®

Castlewood Tall Traditional and Transitional Chimney Range Hoods offer an alternative and updated look to the traditional chimney hood design. Heights and depths can be customized upon request. Hardwood Plywood and Solid Lumber construction.



Scan here to view this range hood's specifications.



SY-WCHH Tall Traditional Chimney Hood

Castlewood Tall Traditional Chimney Range Hoods are available in 32-3/4", 38-3/4", 44-3/4", and 50-3/4" overall widths. Standard Height is 42". Optional Custom Chimney Extensions are available for taller ceiling heights. Detachable Upper Access is standard.

Standard species include **Alder, Cherry, Hickory, Maple, Red Oak, Plain Sawn White Oak and Rift Cut White Oak.**

Design enhancements including Moldings, Overlays and Rosettes can be found throughout this catalog.

Available accessories include Stainless Steel or Silver Metallic Steel liners, 300CFM, 400CFM, and 600CFM Broan Ventilation units, 350CFM, 500CFM, 620CFM, 900CFM and 1200CFM Ascension Ventilation units and ductless conversion kits.

Castlewood Transitional Chimney Range Hoods are available in 31", 37", 43", and 49" overall widths. Each standard configuration is designed to be used with 9' ceilings. A 16-1/4" Chimney Extension is included. Optional Custom Chimney Extensions are available for taller ceiling heights. Detachable Upper Access is standard.

Standard species include **Alder, Cherry, Hickory, Maple, Red Oak, Plain Sawn White Oak and Rift Cut White Oak.** *Design enhancements including Moldings, Overlays and Rosettes can be found throughout this catalog.*

Available accessories include Stainless Steel or Silver Metallic Steel liners, 300CFM, 400CFM, and 600CFM Broan Ventilation units, 350CFM, 500CFM, and 620CFM Ascension Ventilation units and recirculation kits.



SY-WCNOSL Transitional Chimney Hood



Cascade Chimney Hood

The **Castlewood Cascade Chimney Hood** is contoured by design to add a sleek and beautiful enhancement to the total kitchen cooking environment. The Cascade Hood style is available in Alder, Cherry, Hickory, Maple, Red Oak, Plain Sawn White Oak and Rift Cut White Oak.

Scan here to view this range hood's specifications.



SY-WCAS-36-M Cascade Chimney Hood



SY-WCAS-36-H



SY-WCAS-36-R

Castlewood Cascade Chimney Range Hoods are available in 30", 36", 42" and 48" overall widths with no extending trim. This design allows the hood to be placed into tighter openings. Standard available heights are 42", 48", and 54". Customized heights, widths, and depths are available by request.

All Castlewood Range Hoods are constructed of hardwood plywood, veneer, and solid hardwood lumber. Solid lumber banding on all exposed bottom edges.

Available accessories include Stainless Steel or Silver Metallic Steel liners, 300CFM, 400CFM, and 600CFM Broan Ventilation units, 350CFM, 500CFM, 620CFM, 900CFM and 1200CFM Ascension Ventilation units, and recirculation kits.



www.castlewood.com Design Enhancements

Arched Chimney Hoods



Castlewood Arched Chimney style Range Hoods offer an alternative look to the traditional chimney hood design. Arched Raised Panel or Plain Arched Valances are available. Heights and depths can be customized upon request. Hardwood Plywood and Solid Lumber construction.



Scan here to view this range hood's specifications.



SY-WCHAP Arched Raised Panel Chimney Hood

Castlewood Arched Valance Chimney Hoods are available in 33-1/8", 39-1/8", 45-1/8", and 51-1/8" overall widths. Each standard configuration is designed to be used with 9' ceilings. Optional Custom Chimney Extensions are available for taller ceilings. Chimney extensions are separate pieces. For 8' ceilings, order your hood without the chimney extension. Removable upper access option available (see page 61).

Standard species include **Cherry, Hickory, Maple and Red Oak**. *A Plain Arched Valance can be substituted for the Raised Panel Valance.* This option could prove useful in a more contemporary design theme. Specify as SY-WCHPV.

Available accessories include Stainless Steel or Silver Metallic Steel liners, 300CFM, 400CFM, and 600CFM Broan Ventilation units, 350CFM, 500CFM, 620CFM, 900CFM and 1200CFM Ascension Ventilation units and recirculation kits.





Gourmet Chimney Hood

Scan here to view this range hood's specifications.



The **Castlewood Gourmet Chimney Hood** is contoured by design to add a sleek and beautiful enhancement to the total kitchen cooking environment. The Gourmet Hood style is available in Alder, Cherry, Hickory, Maple, Red Oak, Plain Sawn White Oak and Rift Cut White Oak.



Castlewood Gourmet Chimney Range Hoods are available in 33-1/4", 39-1/4", 45-1/4" and 51-1/4" overall widths. The standard height is 31". Optional Custom Chimney Extensions are available in 14", 24" and 36" heights to fit taller ceiling heights.

Removable upper access option available (see page 61).

All Castlewood Range Hoods are constructed of hardwood plywood and solid hardwood. *A wide range of design enhancements including Molding Trim Kits and Ornaments can be found throughout this catalog.*

Available accessories include Stainless Steel or Silver Metallic Steel liners, 300CFM, 400CFM, and 600CFM Broan Ventilation units, 350CFM, 500CFM, 620CFM, 900CFM and 1200CFM Ascension Ventilation units, and recirculation kits.

SY-WCVS
Gourmet Chimney Hood

www.castlewood.com

Design Enhancements



Epicurean Chimney Hood

The **Castlewood Epicurean Chimney Hood** is a taller version of the Gourmet Hood design. This elegant model will make a bold statement within the overall kitchen design. The Epicurean is available in Alder, Cherry, Hickory, Maple, Red Oak, Plain Sawn and Rift Cut White Oak.



Scan here to view this range hood's specifications.



SY-WCVH

Epicurean Chimney Hood



All Castlewood Epicurean Chimney Range Hoods are constructed of hardwood plywood and solid hardwood. These hoods are made available in 33-1/4", 39-1/4", 45-1/4" and 51-1/4" overall widths. Standard available heights are 42-1/2", 48", and 54".

Available accessories include Stainless Steel or Silver Metallic Steel liners, 300CFM, 400CFM, and 600CFM Broan Ventilation units, 350CFM, 500CFM, 620CFM, 900CFM and 1200CFM Ascension Ventilation units, Recirculation Kits, Molding Trim Kits, and Chimney Extensions.



SY-WCVA

Epicurean Arch



SY-WCVAC

Epicurean Elite



SY-WCVX

Executive Chimney Hood

Removable Upper Access option available
(See page 61)



Shiplap Chimney Hoods

One of the hottest kitchen design trends is the use of “Shiplap” Planks. **Castlewood** offers two versions of Chimney style range hoods that employ the shiplap look and construction.



SY-WCSLR Rustic Shiplap Chimney Hood



SY-WCSL Shiplap Chimney Hood



Alder



Hickory



Cherry



Dark Gray



Light Gray

Castlewood Shiplap hoods are available in “smooth plank” and “rustic plank” versions. The smooth plank version is available in Alder, Cherry, Hickory, Maple, Red Oak, and White Oak. These units are sanded to 220 grit and ready for finishing. The rustic plank version is available in Spruce and is pre-finished with a Sherwin Williams stain. Six standard finishes (BK) Black, (BR) Brown, (DG) Dark Gray, (LG) Light Gray, (WH) White and (WW) Whitewash are available. The “rustic” plank is weathered with a heavy texture. Both of these chimney hood styles are available in 31”, 37”, 43” and 49” widths and come standard in 42-1/2” height that includes a 15” Chimney Extension. Optional chimney extensions are available in 26-1/4” and 37-1/2” heights to accommodate a variety of ceiling dimensions. Available accessories include Stainless Steel liners, and 300CFM, 350CFM, 400CFM, 500CFM and 620CFM Ventilation units. A **Removable Upper Access** panel option is available.



www.castlewood.com

Design Enhancements

Shiplap Epicurean Chimney

Castlewood®

The Castlewood Epicurean range hood is now available in “**Shiplap**”. This new configuration offers high style with the warmth and charm of rustic shiplap planks. Available hardwood species include Alder, Cherry, Hickory, Maple, Red Oak, and White Oak. Pre-Finished Distressed Rustic Spruce available in Brown and Whitewash.



The Epicurean Shiplap Chimney hood is available with smooth hardwood planks in 33-1/4", 39-1/4", 45-1/4", and 51-1/4" widths.

A Rustic version is available in 31", 37", 43", and 49" widths. Standard available heights are 42-1/2", 48", and 54". Optional 14", 24" and 36" chimney extensions are available.

This chimney range hood is designed to accommodate the full line of Ascension ventilation units in CFM configurations from 350 to 1200. Stainless Steel liners are available. 31" models can only accommodate ventilation units up to 500 CFM.





XL Shiplap Chimney Hoods

The **Castlewood XL Shiplap Range Hoods** are available in both smooth hardwood and rustic Spruce versions. The XL configuration allows for the mounting of larger sized ventilation systems including the Ascension 900 and 1200 CFM models.

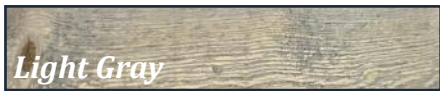

SY-WCSLXXL-A



SY-WCSXLR-WW

XL Shiplap Chimney hoods are available in 31", 37", 43" and 49" widths. Standard available height is 42-1/2" and includes a trim-able 15" tall chimney extension. This height works well with 9' ceilings. Optional 26-1/4" and 37-1/2" chimney extensions are available for taller ceiling heights. The Rustic XL Chimney Hood is made from solid Spruce and comes prefinished with a Sherwin Williams stain. Available finishes are Black (BK), Brown (BR), Dark Gray (DG), Light Gray (LG), White (WH), and Whitewash (WW). The Smooth Hardwood XL Chimney Hood is made of solid hardwood and comes unfinished in Alder, Cherry, Hickory, Maple, Red Oak, and White Oak. These range hood models are designed to accommodate the larger Ascension ventilation units. The 31" and 37" models accept the 900 CFM Ascension Ventilator. The 43" and 49" models accept the 1200 CFM Ascension Ventilator. Stainless Steel liners are also available.



www.castlewood.com Design Enhancements

Corbel Chimney Hoods



Castlewood Corbel Chimney Hoods will make an elegant upscale addition to any kitchen. These beautifully designed hardwood range hoods are available in Cherry, Hard Maple and Red Oak. Additional decorative enhancements including Corbels, Legs and Ornaments can be used to further embellish the overall kitchen design.



Scan here to view this range hood's specifications.



Castlewood Corbel Chimney Hoods are available in 33", 39", 45" and 51" overall widths. These finely crafted units are designed to be used with 9' ceilings and include hand carved details. Optional accessories include Stainless Steel or Silver Metallic Steel Liners, 300CFM -1200CFM Ventilation units, Recirculation Kits and Chimney Extensions.

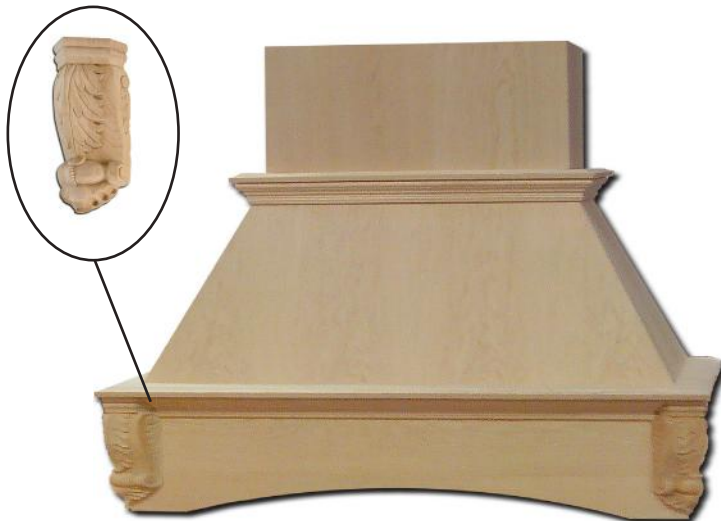

SY-WCHAC
Acanthus Chimney Hood



SY-WCHAS
Ascension Chimney Hood



Island Chimney Hoods

Castlewood Island Chimney Hoods offer designers a hardwood range hood ventilation option for peninsula and island cooktop applications. These hoods are designed to be suspended from the ceiling and will become the centerpiece of your cooking environment.

Scan here to view this range hood's specifications.



SY-WICHAP
Arched Island Chimney Hood



SY-WICHAC
Acanthus Island Chimney Hood



SY-WICH
Island Chimney Hood

Castlewood Island Chimney Hoods are available in 40-3/8" and 52-3/8" overall widths. The standard height is 42-1/2" which includes a 14" Chimney Stack. Optional 24" and 36" Chimney Extensions are also available.

Available species include Alder, Cherry, Hickory, Maple and Red Oak.

Available accessories include Stainless Steel or Silver Metallic Steel liners, 300CFM, 400CFM, and 600CFM Broan Ventilation units, 350CFM, 500CFM, 620CFM, 900CFM and 1200CFM

Ascension Ventilation units and Recirculation kits.



SY-WICSL
Shiplap Island Chimney Hood



Chimney Hood Fronts

Castlewood Chimney Hood Fronts are an economical way to add style and value to your kitchen interior. Chimney hood fronts fit between wall cabinets to simulate a fully boxed cabinet. When metal liners and ventilation units are installed, these range hood fronts blend seamlessly into the overall kitchen design.



Scan here to view this range hood's specifications.



Castlewood Chimney Hood Fronts are available in 30" and 36" widths and 24", 30", and 36" heights. Each of these units is constructed of hardwood plywood and solid lumber.

Available accessories include Silver Metallic Steel liners, 300CFM, 400CFM, and 600CFM Broan Ventilators, 350CFM, 500CFM, and 620CFM Ascension Ventilators and Recirculation kits. Optional Trim Kits and Moldings are also available.



SY-JSLHF
Shiplap Hood Front



SY-JSLRHF
Rustic Shiplap Hood Front



SY-JCHF3036
Chimney Hood Front



SY-JCHF
Chimney Hood Front



SY-JCHFP
Arched Chimney Hood Front



SY-JSKHF
Shaker Hood Front



Mantel Range Hoods

Castlewood Mantel Style Range Hoods will provide bold character and stately elegance to any kitchen decor. Mantel Range Hoods come with a variety of valance and molding options and are sized to accommodate larger ovens and ventilation systems. These deluxe units are available in Cherry, Hickory, Maple and Red Oak.

Scan here to view this range hood's specifications.



SY-WMHS
Mantel Range Hood



SY-WMHRP
Arched RP Valance Mantel Hood



SY-WMHAP
Arched Plain Valance Mantel Hood

Castlewood Mantel Hoods are available in 42" x 30", 42" x 36", 48" x 30", 48" x 36", 60" x 30" and 60" x 36". Each standard configuration is designed to be used with consumer supplied doors to match the overall kitchen design. Increased heights/depths are available. All Mantel Hoods are constructed of hardwood plywood and solid hardwood. These units are suitable for both frame and frameless applications. Available accessories include Stainless Steel or Silver Metallic Steel liners, 300CFM, 400CFM, and 600CFM Broan Ventilation units, 350CFM, 500CFM, 620CFM, 900CFM and 1200CFM Ascension Ventilation units and recirculation kits.



www.castlewood.com Design Enhancements

Connoisseur Mantel Hoods

The **Castlewood Connoisseur Mantel Hoods** include classic design elements with arched valances and detachable upper panels for easy access. Panels and Valances can be **raised or solid**. A variety of corbel designs can be employed to give the hood a personal touch.



Scan here to view this range hood's specifications.



Castlewood Connoisseur Mantel Hoods are available in 30" and 42" heights. Standard available widths include 30", 36", 42" and 48". Standard box depth is 19". Increased depth options are available. These mantel hoods are designed to accept both the HLB and HLZ series rectangular Stainless Steel or Silver Metallic Steel liners. Ventilation options from 300CFM to 1200CFM.



SY-WMDP42
Connoisseur Mantel Hood



SY-WMDPC42
Connoisseur Classic Mantel Hood

Connoisseur Mantel Hoods come standard with Mission Corbels and Raised Panels. Alternate designs include **Acanthus** corbels with raised panels (**SY-WMDPA**), **Classic** corbels with arched plain valance (**SY-WMDPC**) and **Shaker** corbels with arched plain valance (**SY-WMDPS**).





Classic Mantel Range Hood

Scan here to view this range hood's specifications.



The **Castlewood Classic Mantel Range Hood** incorporates attached pillars, classic scroll corbels, a traditional mantel shelf and a decorative front panel with applied molding. This elegant design will become the focal point of a timeless kitchen theme.



SY-CMH
Classic Mantel Hood

The **Classic Mantel Hood** is built 48" high including pillars and is available in 46", 52", 58" and 64" widths. The overall depth including mantel shelf is 25-1/2".

This mantel hood design is constructed of select hardwood plywood and solid hardwood lumber. Available species include Cherry, Hickory, Maple and Red Oak.

This fine unit is designed to accept any of the quality ventilation options found within this catalog including Stainless Steel or Silver Metallic Steel liners, 300CFM, 400CFM, and 600CFM Broan Ventilation units or 350CFM, 500CFM, 620 CFM, 900CFM and 1200CFM Ascension Ventilation units. Custom widths and depths options are available by request.

www.castlewood.com

Design Enhancements



Shiplap Box & Mantel Hoods



The **Castlewood Shiplap Box and Mantel Hoods** offer modern design elements with either a slim cabinet depth profile or a full bodied box profile with increased depth to accommodate larger ventilation options. Available species include Alder, Cherry, Hickory, Maple, Red Oak, and White Oak.



Scan here to view this range hood's specifications.



SY-WSLB
Shiplap Box Hood

Front panel is removable for easy access



SY-WSLBA
Shiplap Arched Box Hood



SY-WSLBA



SY-WMC

Castlewood Shiplap Box and Mantel Hoods are available in 36" and 42" heights. Standard widths are 36", 42", 48" and 60".

These mantel hoods are designed to accept the HLB series Stainless Steel or Silver Metallic steel liners. Ventilation options from Broan and Ascension in 300CFM, 350CFM, 400CFM, 500CFM, 600CFM, and 620CFM configurations. SY-WSLB and SY-WSLBA will also accept the Ascension 900CFM and 1200CFM ventilation units.

The front panels are detachable for easy access.

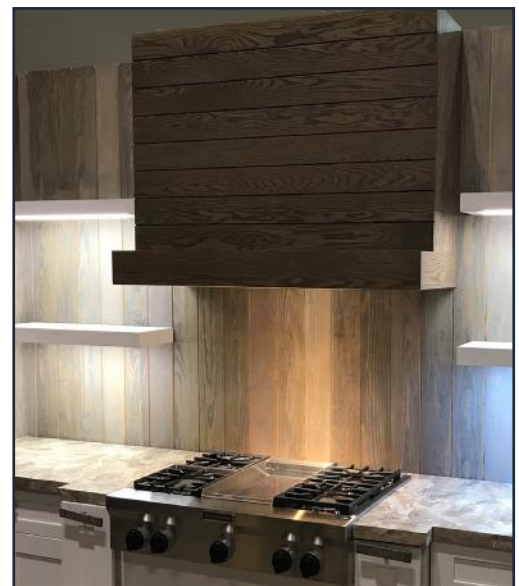



Contemporary Box Hood

Scan here to view this range hood's specifications.



The **Castlewood Contemporary Plain Box Hood** offers a sleek modern design. This contemporary configuration has no trim extensions and is designed to fit into tight spaces giving the kitchen a most up to date modern look.

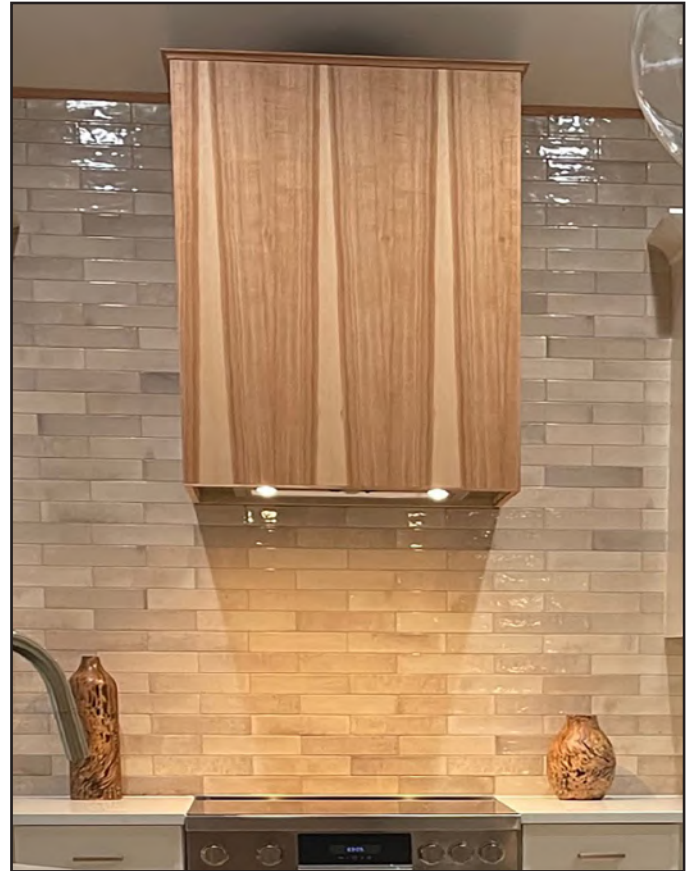

SY-WBXH3642-M

The **Contemporary Plain Box Range Hood** is constructed from selected hardwood plywood and hardwood lumber.

Standard available widths are 30" 36" 42" and 48".

Standard available heights are 30" 36" 42" and 48".

Custom sizing is available by request.

Available species include Alder, Cherry, Hickory, Maple, Red Oak, Plain Sawn and Rift Cut White Oak. Solid Lumber banding along exposed bottom edges.

These contemporary units are designed to accept any of the ventilation options found within this catalog including Stainless Steel or Silver Metallic Steel liners, 300CFM, 400CFM, and 600CFM Broan Ventilation units or 350CFM, 500CFM, 620 CFM, 900CFM and 1200CFM Ascension Ventilation units.



www.castlewood.com

Design Enhancements

2 Piece Box Hoods



The **Castlewood 2 Piece Box Hoods** offer unique design flexibility within a modern format. With a mix-and-match design, consumers can combine different species together to achieve their desired look. Top and Bottom sections are ordered separately. Solid hardwood bottoms are paired with smooth plywood or shi lap plank tops.



Scan here to view this range hood's specifications.



SY-WBXHDBS30-R Bottom with SY-WBXHDT3024-M Top



SY-WBXHDBS30-R Bottom with SY-WBXTSL3024-M Top



Castlewood 2 Piece Box Hoods are available in 30", 36", 42", and 48" heights and widths. Customized heights and widths are available.

Available species include Alder, Cherry, Hickory, Maple, Red Oak, Plain Sawn and Rift Cut White Oak. Shi lap Tops are not available in Rift Cut White Oak.

These 2 piece hoods are designed to accept any of the ventilation options found in this catalog including Stainless Steel or Silver Metallic steel liners, 300CFM, 400CFM, and 600CFM Broan ventilation units, or 350CFM, 500CFM, 620CFM, 900CFM, and 1200CFM Ascension units.



SY-WBXHDBS30-R



SY-WBXTSL3024-M





Mantel Hood Fronts

Castlewood Mantel Hood Fronts are an economical way to add style and value to your kitchen interior. Mantel hood fronts are sold without doors to allow for customization to match the design of the kitchen. These units will fit between wall cabinets to simulate a fully boxed hardwood range hood.

Scan here to view this range hood's specifications.



SY-JSMHF
Shaker Mantel Hood Front



SY-JSLMHF
Shiplap Mantel Hood Front



SY-JSVHF
Mantel Range Hood Front



SY-JAVHF
Arched RP Valance Mantel Hood Front



SY-JCMHF
Coved Mantel Hood Front

Castlewood Mantel Hood Fronts are available in 30" and 36" widths and 24", 30" and 36" heights. Each of these units is constructed of solid hardwood. Available species include Cherry, Hickory, Hard Maple and Red Oak. Optional accessories include alternative Moldings, Silver Metallic Steel Liners, 300CFM, 400CFM, and 600CFM Broan Ventilators, 350CFM, 500CFM, AND 620CFM Ascension Ventilators and recirculation kits. Optional Trim Kits and Moldings are also available.



www.castlewood.com Design Enhancements

Mantel Hood Pillars

To further complete the overall mantel hood design, **Castlewood** offers **Mantel Hood Pillars** in a variety of customizable configurations. Pillars are constructed of hardwood plywood and solid lumber. The units are sold in pairs and are built to accept corbels and door panels.



Scan here to view the Mantel Hood Pillar collection.



Castlewood Pillars have frameless construction. The SY-FPP-6 series comes standard in 6" widths and is available in 60" and 66" heights. These units include **Spice Pullouts** with ball bearing slides. The SY-FPP-9 series comes standard in 9" widths and is available in 44", 50" and 56" heights. A variety of corbels are available to enhance the appearance and can be found on page 17 of this catalog.



SY-FPP-9



SY-FPP-6



Paint Grade Chimney Hoods

Scan here to view this range hood's specifications.



Paint Grade Chimney Hoods are part of the Castlewood Quick-Ship program. These hoods are constructed from hardwood lumber and MDF panels and come already primed for easy application of your preferred color. All products in the Quick-Ship program ship from stock in 2 days or less.



SY-WCSL36-IM Shiplap Chimney Hood



SY-WCH30-IM

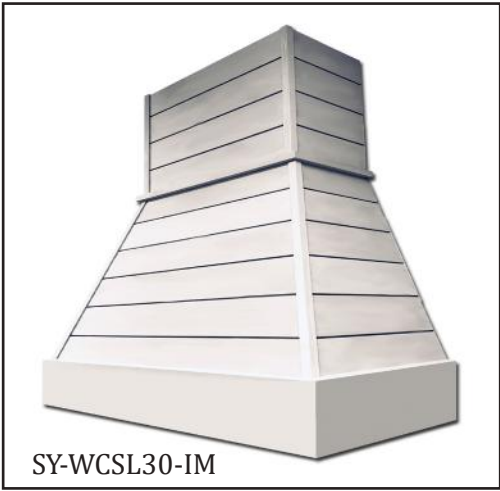

SY-WCSL30-IM

Castlewood Paint Grade Chimney Range Hoods are available in two styles, Traditional and Shiplap. There are two available widths, 30" and 36". Both designs include a removable chimney extension. The Traditional Paint Grade Chimney Hood is 44-1/2" tall and the Shiplap Paint Grade Chimney Hood is 42-1/8" tall. The Shiplap version comes in either RTA or fully assembled versions.

Available accessories include Stainless Steel or Powder Coated Silver Metallic Steel liners, 300CFM, 400CFM, and 600CFM Broan Ventilation units, 350CFM, 500CFM, 620CFM, and 900CFM Ascension Ventilation units, Recirculation kits, Charcoal and Hybrid Baffle Filters.

All hoods in this program are delivered already primed and are guaranteed to ship within 2 days.

Paint Grade Chimney Hood Fronts



Scan here to view this range hood's specifications.

Paint Grade Chimney Hood Fronts are part of the Castlewood Quick-Ship program. These hoods are constructed from hardwood lumber and MDF panels and come already primed for easy application of your preferred color. All products in the Quick-Ship program ship from stock in 2 days or less.



SY-JCHF3024-IM *Chimney Hood Front*



SY-JSKHF3024-IM *Shaker Hood Front*



Castlewood Paint Grade Chimney Hood Fronts are available in two styles, Traditional and Shaker. There are two available widths, 30" and 36", and two available heights 24" and 30".

Available accessories include T-shaped Powder Coated Silver Metallic Steel liners, 300CFM, 400CFM, and 600CFM Broan Ventilation units, 350CFM, 500CFM, and 620CFM Ascension Ventilation units, Recirculation kits, Charcoal and Hybrid Baffle Filters.

All hoods in this program are delivered already primed and are guaranteed to ship within 2 days.



Range Hood Ventilation

Scan here to view the
Castlewood Ventilators
features and specifications.



Castlewood features a selection of **Range Hood Ventilation** options by Ascension and Broan. Standard configurations include 300CFM, 350CFM, 400CFM, 500CFM, 600CFM, 620CFM, 900CFM and 1200CFM Power Packs with internal motors, Stainless Steel or Powder Coated Silver Metallic Steel Liners and optional Ductless Conversion Kits.



SY-HVA-350-SL
Ascension 350CFM Silver Metallic



SY-HVA-350-SS
Ascension 350CFM Stainless Steel



SY-HVA-500-SS
Ascension 500CFM Stainless Steel



SY-HVA-620-SS
Ascension 620CFM Stainless Steel

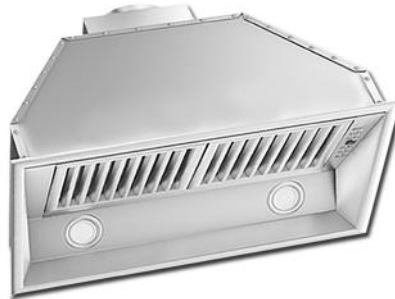

SY-HVA-900-SS
Ascension 900CFM Stainless Steel

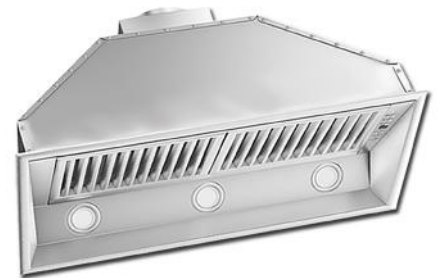

SY-HVA-1200-SS
Ascension 1200CFM Stainless Steel



SY-HV-300SS
Broan 300CFM Stainless Steel



SY-HV-400SS
Broan 400CFM Stainless Steel



SY-HV-600SSV
Broan 600CFM Stainless Steel



SY-H357NDK

SY-HVA-SDK



SY-HLB



SY-HLT



SY-HLZ

Castlewood HLB series liners are used in all Chimney and Mantel Hood configurations.
HLT series liners are used with Chimney Hood Fronts and Mantel Hood Fronts only.
The **HLZ** series liners are used with the Ascension HVA900 and HVA1200 ventilators only.



www.castlewood.com Design Enhancements

Range Hood Corbels

Castlewood Range Hood Corbels are designed to be supportive and enhance range hood appearance and application. All models are equipped with steel keyslot mounting brackets for extra strength and stability. Made from select North American Hardwoods.



Scan here to view the Range Hood Corbel features and specifications.



SY-CA-144
(18" x 3-1/2" x 12")



SY-CA-145
(18" x 3-1/2" x 12")



SY-CA-3
(12" x 3" x 12")



SY-CA-7
(14" x 3" x 10")



SY-JL-BB20
(16" X 3" X 12")



SY-CA-8
(13" x 2-7/8" x 3")



SY-CA-68
(13" x 2-7/8" x 3")



SY-CA-105
(12-1/2" x 5-1/4" x 4-1/2")



SY-CA-122
(10" x 3-3/8" x 2-3/8")



SY-CA-123
(10" x 3-3/8" x 2-3/8")



SY-CA-161
(13" x 2-7/8" x 3-1/2")



SY-CA-6
(9" x 6" x 4")



SY-CA-66
(9" x 6" x 4")



SY-CA-98
(12" x 5" x 4-1/2")



SY-CA-106
(9-3/4" x 5-3/4" x 4-1/2")



SY-CA-121
(10" x 4-3/4" x 1-3/4")



SY-CA-209
(11-3/4" x 3" x 7-3/8")

Castlewood Range Hood Corbels are available in a variety of species including Alder, Birch, Cherry, Maple and Red Oak. Many of these will work with the FPP-6 and FPP-9 series Pillars.



White Oak Collection

White Oak cabinets have become increasingly popular in modern kitchen design. Their sleek, clean lines, and light color create a fresh and timeless look to any space. **Castlewood** now offers a select grouping of enhancements to augment your kitchen design in White Oak.

Scan here to view the *White Oak Collection* including specifications and line drawings.



SY-WBXH-WO



SY-L-5039-WO
(35-1/4" x 3-1/2")



SY-L-5052-WO
(35-1/4" x 3")



SY-L-5065-WO
(35-1/4" x 5")



SY-BF-194-WO
(4" x 4" x 2-1/2")



SY-BF-197-WO
(4-1/2" x 2-1/2" x 2-1/2")



SY-BF-198-WO
(4-1/2" x 4-3/4" x 2-1/2")



SY-BF-201-WO
(4-1/2" x 4" x 2-1/2")



SY-P-5035-WO
(35-1/4" x 3-1/2")



SY-P-5046-WO
(35-1/4" x 2-1/2")



SY-P-5058-WO
(35-1/4" x 4")



SY-P-5059-WO
(35-1/4" x 5")



White Oak Collection

Virtually all **Castlewood Hardwood Range Hoods** and **Floating Shelves** are now available in **White Oak**, as well as, a selection of **Brackets, Corbels, Feet, Legs, and Posts**. Keep up with the current design trends with **Castlewoods White Oak Collection**.



Scan here to view the **White Oak Collection** including specifications and line drawings.



SY-WCH-WO



SY-WCHGH-WO



SY-CA-7-WO
(14" x 3" x 10")



SY-CA-211-WO
(9" x 3" x 5-1/2")



SY-CA-CC29-WO
(9" x 1-3/4" x 6")



SY-CA-CC212-WO
(12" x 1-3/4" x 8")



SY-CA-BB1-WO
(10" x 2-3/4" x 10")



SY-CA-BB3-WO
(8" x 2-5/8" x 8")



SY-CA-BB16-WO
(10" x 2" x 10")



SY-JL-BB4-WO
(8" x 2-5/8" x 8")



Shiplap Collection

Scan here to view the *Shiplap Collection* including specifications and line drawings.



The use of *Shiplap Planks* to add a more rustic feel to home interiors has become increasingly popular. Castlewood manufactures Shiplap planks in a variety of species. With this collection we offer suggestions for accompanying accessory items to compliment the Shiplap design theme.

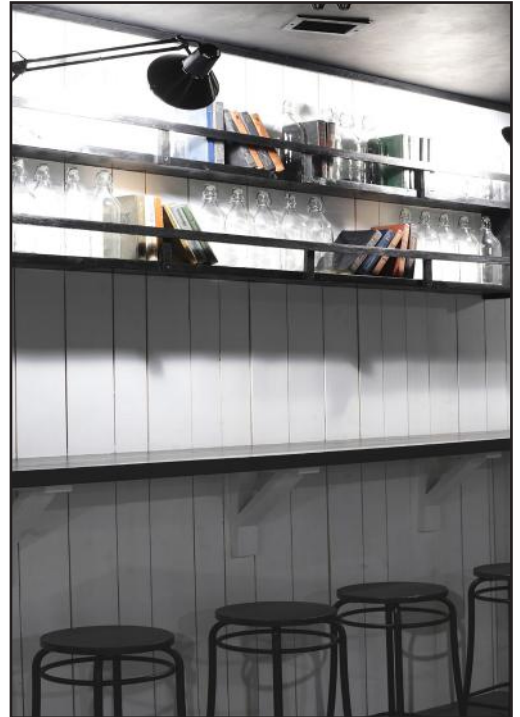

SY-JL-BB20
(16" x 3" x 12")



SY-JL-BB9
(10" x 2-5/8" x 10")



SY-BF-201
(4-1/2" x 4" x 2-1/2")



SY-JL-BB8
(8" x 2-5/8" x 8")



SY-JL-B21
(6-1/2" x 3" x 4")



SY-JL-BB22
(13" x 3" x 4")



SY-JIESL
(35-1/4" x 24" x 3")



SY-L-5052
(35-1/4" x 3")



SY-L-5065
(35-1/4" x 4-1/2")



www.castlewood.com

Design Enhancements

Shiplap Collection



Scan here to view the Shiplap Collection including and line drawings.

Castlewood Shiplap Planks are used to produce our shiplap style Chimney and Box Range Hoods. These same planks are available individually for use as back splashes and wall decor. The Shiplap Planks have rabbeted ends to allow for overlapping joints that will completely conceal the surface behind.



ALDER



CHERRY



HICKORY



MAPLE



RED OAK

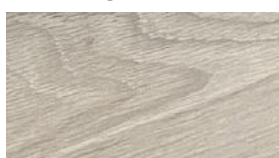

WHITE OAK

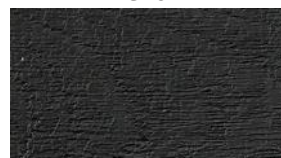

BLACK (SPRUCE)



BROWN (SPRUCE)



DARK GRAY (SPRUCE)



LIGHT GRAY (SPRUCE)



WHITE (SPRUCE)



WHITE WASH (SPRUCE)

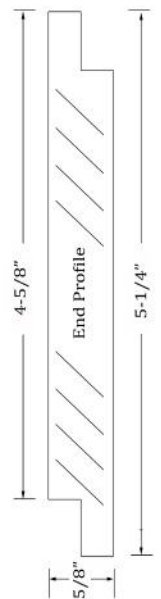

Shiplap Planks are available in 48" and 96" lengths.

Castlewood Shiplap Chimney Hoods are found on page 8.
Shiplap Box and Mantel Range Hoods are found on page 17.



Acanthus Collection

The Acanthus leaf design dates back to ancient Greece. The style was elaborated by the Romans and revived during the Renaissance.

This timeless architectural element is still widely used today. The **Acanthus Collection** offers a variety of Acanthus adorned carved wood components to add elegance and historic beauty to any project.

Scan here to view the *Acanthus Collection* including specifications and line drawings.



SY-CA-01
(12" x 3-1/2" x 9")



SY-CA-05
(12" x 3-1/2" x 9")



SY-CA-98
(12" x 5" x 4-1/2")



SY-CA-205
(12" x 2-1/2" x 8")



SY-CA-120
(14" x 6" x 2-1/2")



SY-CA-121
(10" x 4-3/4" x 1-3/4")



SY-CA-203
(6" x 2-3/4" x 2-1/2")



SY-CA-204
(10" x 4-7/8" x 2-1/2")



SY-L-5037
(35-1/4" x 3-1/2")



SY-P-5032
(35-1/4" x 3-1/2")



www.castlewood.com

Design Enhancements

Acanthus Collection

The **Acanthus Collection** items are constructed from select solid hardwoods and are available in Birch, Cherry, Maple, and Red Oak. Each piece is hand detailed and ready for finishing.



Scan here to view the *Acanthus Collection* including specifications and line drawings.



SY-CA-71
(22" x 6-3/4" x 7-11/16")



SY-CA-219
(9" x 5-3/4" x 6-1/16")



SY-CA-221
(13" x 2-7/8" x 9-3/16")



SY-3030
(5-5/8" x 20" x 1")



SY-3043
(5-1/2" x 20" x 5/8")



SY-O-047
(7-1/2" x 36" x 1")
SY-O-048
(6" x 24" x 3/4")
SY-O-049
(4" x 12" x 5/8")



SY-O-227
(4-1/2" x 20" x 5/8")



SY-2252
(2-7/8" x 2-7/8" x 1/2")
SY-2255
(5" x 5" x 3/4")



SY-RS-173
(4-1/2" x 2-3/4" x 5/8")



SY-BF-186
(4-1/2" x 3-1/2")



SY-2253
(2-7/8" x 2-7/8" x 1/2")
SY-2256
(5" x 5" x 3/4")



SY-RS-250
(2-7/8" x 2-7/8" x 3/8")



SY-CA-125
(4-1/2" x 3" x 1-3/4")



SY-MD-7015
(2" x 96" x 1/2")



SY-MD-6058
(6-3/4" x 96" x 1-3/4")

www.castlewood.com

Design Enhancements





Classic Collection

The Acanthus leaf design dates back to ancient Greece. The style was elaborated by the Romans and revived during the Renaissance.

This timeless architectural element is still widely used today. The **Acanthus Collection** offers a variety of Acanthus adorned carved wood components to add elegance and historic beauty to any project.

Scan here to view the Classic Collection including specifications and line drawings.

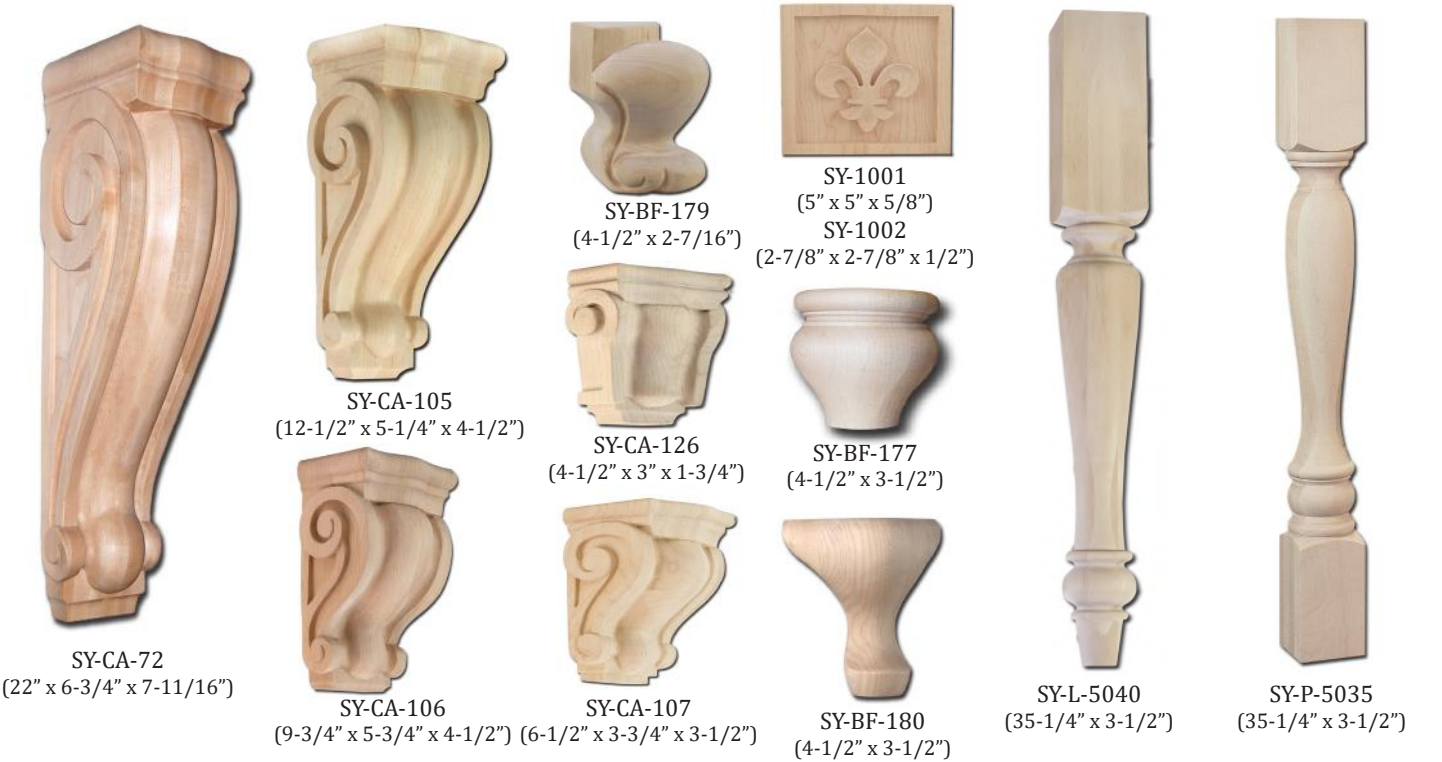

Mission Collection

The Mission style of architecture emerged in the later part of the 19th century. The design theme is traditionally plain and heavy. This style is characteristic of the Spanish Missions of the Southwestern United States. **Castlewood's Mission Collection** offers several bold elements to fortify and enhance your decor.



Scan here to view the entire *Mission Collection* including specifications and line drawings.

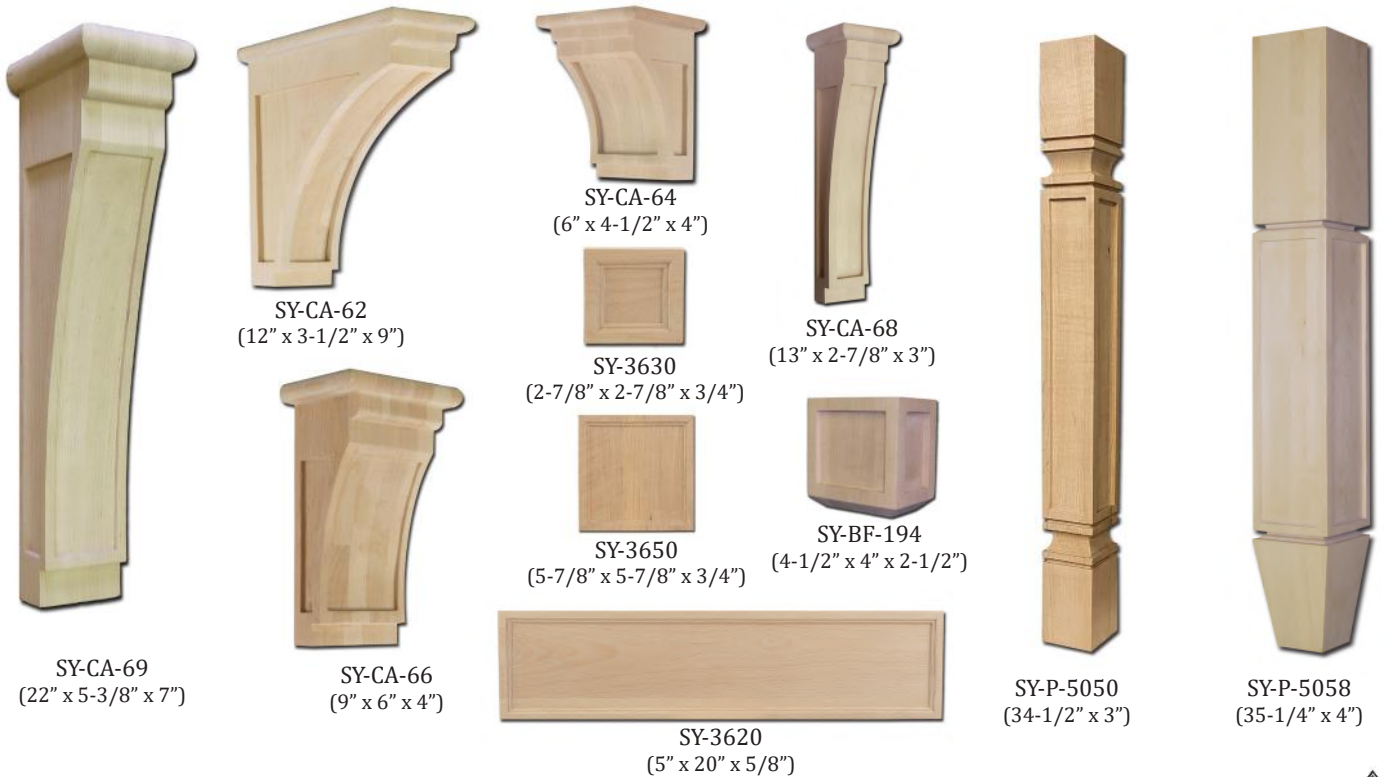



Shaker Collection

The **Shaker** design style emerged in the mid 19th century and was created by the Shaker religious sect. The style is minimalistic, with clean and simple lines. These underlying design principals have inspired **Castlewood's Shaker Collection**, an offering of simplistic architectural elements for todays more conservative design themes.

Scan here to view the entire *Shaker Collection* including specifications and line drawings.



www.castlewood.com

Design Enhancements

Woven Collection

The Basket Weave and Lattice design styles became popular in 14th century Europe. The style involves the plaiting of wooden slats, interwoven to resemble a basket. Lattice panels were commonly employed as door inserts or privacy screens. These two design themes are combined to create **Castlewood's Woven Collection**, an offering of intricate hand carved decoration for more elaborate designs.



Scan here to view the entire *Woven Collection* including specifications and line drawings.

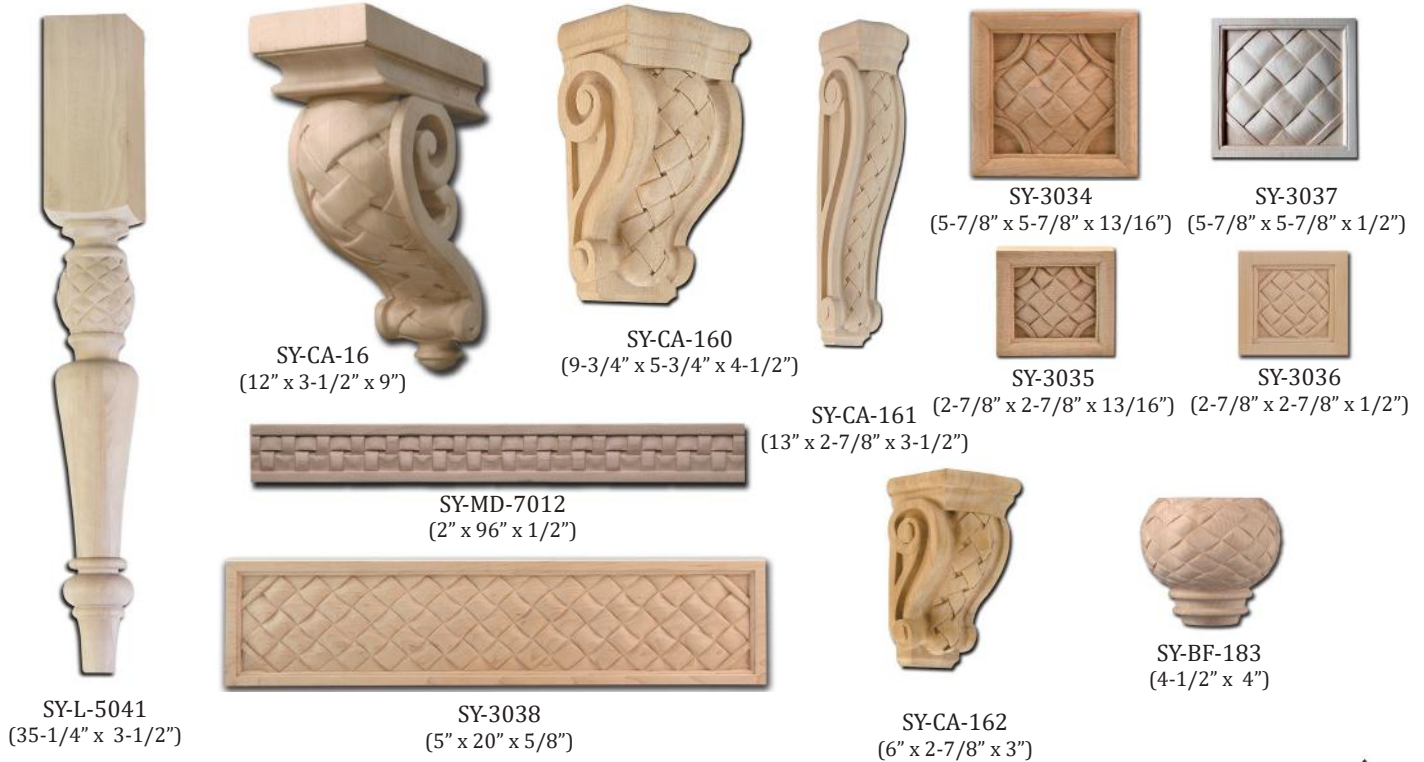

Castlewood®

Traditional Scroll Collection

Scan here to view the entire *Traditional Scroll Collection* including specifications and line drawings.



One of the more customary and established design elements in carved wood decoration is the *Scroll*. The Scroll motif has been used throughout modern woodworking history to convey a feeling of stately elegance. **Castlewood's Traditional Scroll Collection** offers an array of architectural embellishments to satisfy the taste for this timeless style.



SY-CA-09-0
(14" x 5" x 7")



SY-CA-10-0
(13 x 3-1/2" x 8")



SY-CA-11-0
(10" x 4-1/2" x 5")



SY-CA-94
(14" x 7" x 6")



SY-RS-02
(5" x 5" x 5/8")



SY-RS-03
(2-7/8" x 2-7/8" x 7/16")



SY-O-042
(7-1/2" x 36" x 1")

SY-O-043
(5" x 24" x 3/4")

SY-O-044
(4" x 12" x 5/8")



SY-P-5033
(35-1/4" x 3-1/2")



SY-P-5034
(35-1/4" x 3-1/2")



www.castlewood.com

Design Enhancements

Traditional Scroll Collection



The **Traditional Scroll Collection** items are constructed from select solid hardwoods and are available in Birch, Cherry, Maple, and Red Oak. Each piece is hand detailed and ready for finishing. Rubberwood and other species are available by request.



Scan here to view the entire *Traditional Scroll Collection* including specifications and line drawings.



SY-CA-09-S
(14" x 5" x 7")



SY-CA-10-S
(13" x 3-1/2" x 8")



SY-CA-11-S
(10" x 4-1/2" x 5")



SY-CA-222
(6" x 3" x 3")



SY-CA-223
(9" x 5-3/4" x 6-1/16")



SY-CA-225
(13" x 2-7/8" x 9-3/16")



SY-BF-181
(4-1/2" x 3-3/16")



SY-BF-182
(4-1/2" x 4-1/4")



SY-BF-189
(4-1/2" x 4-1/4")



SY-BF-198
(4-1/2" x 4-3/4" x 2-1/2")



SY-P-5036
(35-1/4 x 3-1/2")



SY-L-5134
(35-1/4 x 3-1/2")





Bar Bracket Collection

Scan here to view the entire *Bar Bracket Collection* including specifications and line drawings.



Castlewood's Bar Bracket Collection is an array of basic wooden supports designed for modern and traditional kitchen counter and bar applications. These designs are available in a variety of hardwoods including Alder, Birch, Cherry, Hickory, Maple, Poplar, Red Oak, Rubberwood and White Oak.



SY-CA-BB-BM (10-1/2" x 2" x 7-1/2") SY-CA-BB1 (10" x 2-3/4" x 10") SY-CA-BB2 (10-3/4" x 2-7/8" x 6-3/8") SY-CA-BB3 (8" x 2-5/8" x 8") SY-JL-BB4 (8" x 2-5/8" x 8")



SY-JL-BB5 (10" x 2-5/8" x 10") SY-JL-BB6 (8" x 1-3/4" x 8") SY-JL-BB7 (10" x 1-3/4" x 10") SY-JL-BB8 (8" x 2-5/8" x 8") SY-JL-BB9 (10" x 2-5/8" x 10")



SY-JL-BB10 (4-1/16" x 2-5/16") SY-CA-BB11 (10" x 2" x 10") SY-CA-BB12 (10" x 2" x 8") SY-CA-BB13 (8" x 2" x 6") SY-CA-BB14 (10" x 2" x 10") SY-CA-BB15 (10" x 2" x 10") SY-CA-BB16 (10" x 2" x 10")

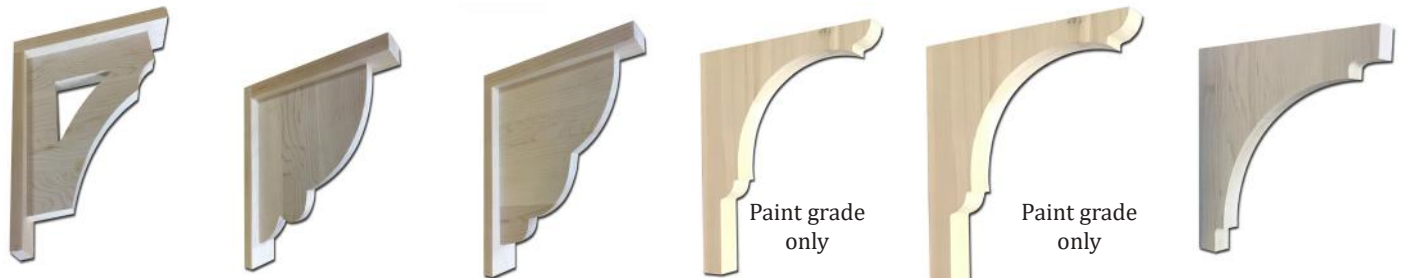

SY-CA-BB17 (10" x 2" x 10") SY-CA-BB18 (10" x 2" x 10") SY-CA-BB19 (10" x 2" x 10") SY-JLBB13 (16" x 2-1/4" x 12") SY-JLBB14 (18" x 2-1/4" x 15-7/8") SY-BB25 (9" x 2-1/4" x 9")

Paint grade only

Paint grade only



www.castlewood.com

Design Enhancements

Countertop Supports

Castlewood's Countertop Support Collection provides a more detailed and intricate selection of support bracket designs for applications where more depth and personality is desired. These designs are available in Alder, Cherry, Maple, Red Oak, Rubberwood, and White Oak. Spice up your kitchen with **Castlewood**.



Scan here to view the entire *Countertop Support Collection* including specifications and line drawings.



SY-CA-01
(12" x 3-1/2" x 9")



SY-CA-2
(12" x 3-1/2" x 9")



SY-CA-05
(12" x 3-1/2" x 9")



SY-CA-7
(14" x 3" x 10")



SY-CA-10-O
(13" x 3-1/2" x 8")



SY-CA-10-S
(13" x 3-1/2" x 8")



SY-CA-16
(12" x 3-1/2" x 9")



SY-CA-CC29
(9" x 1-3/4" x 6")



SY-CA-62
(12" x 3-1/2" x 9")



SY-CA-100
(13" x 3-1/2" x 8")



SY-CA-205
(12" x 2-1/2" x 8")



SY-CA-206
(10" x 2-1/2" x 7")



SY-CA-207
(12" x 2-1/2" x 9")



SY-CA-208
(12" x 3-1/8" x 6-1/2")



SY-CA-209
(11-3/4" x 3" x 7-3/8")



SY-CA-210
(14" x 2-1/2" x 9")



SY-CA-211
(9" x 3" x 5-1/2")



SY-CA-CC212
(12" x 1-3/4" x 8")



SY-CA-225
(13" x 2-7/8" x 9-3/16")



SY-CA-917
(12" x 2-1/2" x 9")





Bun Feet Collection

Castlewood's **Bun Feet Collection** offers a broad assortment of turned feet and small hand carved legs for kitchen and vanity cabinet applications. These designs will turn stock cabinets into stand alone furniture. Available species include Alder, Birch, Cherry, Hickory, Maple, Red Oak, Rubberwood, and White Oak. (4" tall versions can be made available by special order)

Scan here to view the entire *Bun Feet Collection* including specifications and line drawings.

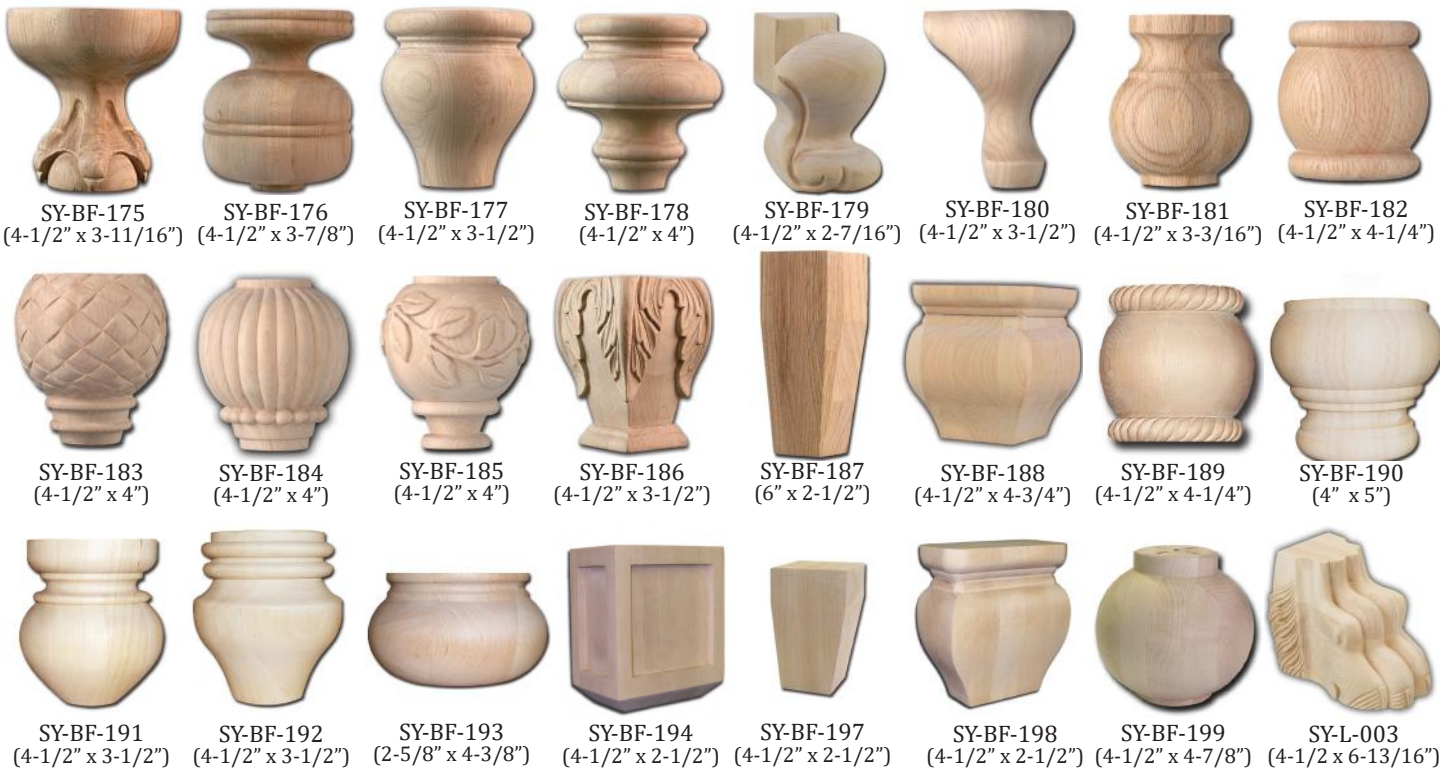

www.castlewood.com

Design Enhancements

Pedestal Feet Collection

Kitchen Islands and Bathroom Vanities can be turned into stand alone furniture pieces with a selection from **Castlewood's Pedestal Feet Collection**. These designs are available in a variety of species including Alder, Birch, Cherry, Maple, Red Oak and Rubberwood.



Scan here to view the entire *Pedestal Feet Collection* including specifications and line drawings.



SY-PF-152
(4" x 8-1/4" x 1")



SY-PF-154
(2-1/2" x 16" x 1")



SY-PF-153
(4" x 8-1/4" x 1")



SY-PF-171
(4-1/2" x 6" x 1")



SY-PF-170
(1-3/4" x 11" x 1-3/4")



SY-PF-172
(4-1/2" x 6" x 1")



SY-PF-151
(4" x 8-1/4" x 8-1/4")



SY-PF-173
(4-1/2" x 6-1/2" x 6-1/2")



SY-PF-174
(4-1/2" x 6" x 6")



Floating Shelves

Scan here to view the *Floating Shelf Collection* including specifications and line drawings.



Castlewood Plain Floating Shelves offer clean and sturdy support for modern kitchen design. These units are a perfect way to display dinner and glassware. A pre-finished Rustic version is now available. All units come with heavy duty hardware that increases weight capacity to over 200 lbs. per shelf.



SY-JMSP
Standard Plain Floating Shelf



SY-JMSPR
Rustic Floating Shelf



SY-JMSPC *Corner Floating Shelf*



Floating Shelf Mounting Hardware



All *Castlewood Plain Floating Shelves* are constructed of hardwood plywood and solid hardwood. Available species include Alder, Cherry, Hickory, Maple, Red Oak, Rustic Spruce, Walnut and White Oak. A *Paint Grade* version is also available as part of the *Castlewood Quick-Ship program*. The Rustic Spruce shelves come pre-finished in Black, Brown, Dark Grey, Light Grey, White and Whitewash. The finish is a Sherwin Williams stain. Standard thickness is 2-1/2". Available depths are 10" and 12". Standard widths are 24", 30", 36", 42", 48", 54", 60", 66" and 72". In between sizes are available as special order. A new Corner Shelf is now available. Each unit comes standard with *Steel Mounting Brackets*. Weight capacity is rated at 200 lbs per shelf. The mounting brackets are poly bagged in kit form and come complete with instructions, templates and fastening hardware.



www.castlewood.com

Design Enhancements

Mantel Shelves

Castlewood Mantel Shelves are designed to be used as stand alone wall display shelves or as part of mantel range hood configurations. Mantel shelves are a perfect way to display decorative and personal articles. Shelves are available in Alder, Cherry, Hickory, Maple, Red Oak, and White Oak.



Scan here to view the *Mantel Shelf Collection* including specifications and line drawings.



SY-JMSA *Traditional Mantel Shelf*



SY-JMSC *Coved Mantel Shelf*



SY-JMSJ *Jumbo Mantel Shelf*

All of the Castlewood **Mantel Shelves** are constructed of solid hardwood lumber and are supplied with a solid hardwood mounting rail. Mantel shelves are rated a 15 lbs per square foot weight capacity.

Standard depth is 6-1/8". Available widths are 24", 30", 36", 42" and 48". These classic profiles will make a beautiful addition to any room in the house.



Island Post Collection

Scan here to view the entire *Island Post Collection* including specifications and line drawings.



Castlewood offers an array of classic **Island Post** designs to perfectly compliment a wide variety of kitchen island configurations. Each post is expertly turned and hand sanded for a superior finish. These designs are available in Alder, Birch, Cherry, Maple Red Oak, Rubberwood, and White Oak.



SY-P-5031 SY-P-5032 SY-P-5033 SY-P-5034 SY-P-5035 SY-P-5036 SY-P-5038 SY-P-5046 SY-P-5050 SY-P-5053

All Island Posts are 35-1/4" x 3-1/2" except SY-P-5046 (35-1/4" x 2-1/2") and SY-P-5050 (34-1/2" x 3")

www.castlewood.com Design Enhancements



Jumbo Posts and Legs

For a more massive and hearty look, **Castlewood** offers the **Jumbo Post & Leg Collection** of extra large turnings. Each post is expertly turned and hand sanded for a superior finish. These larger designs are available in Birch, Cherry, Maple, Red Oak, and White Oak.



Scan here to view the entire **Jumbo Post and Leg Collection** including specifications and line drawings.



SY-P-5044
(42" x 5")

SY-P-5045
(42" x 5")

SY-P-5047
(42" x 5")

SY-P-5048
(42" x 5")



SY-L-5054
(34-1/2" x 4")

SY-L-5055
(34-1/2" x 8")

SY-L-5057
(34-1/2" x 6")

SY-P-5058
(35-1/4" x 4")

SY-P-5059
(35-1/4" x 5")

SY-P-5060
(35-1/4" x 5")

SY-P-5061
(35-1/4" x 5")

www.castlewood.com

Design Enhancements





Table Leg Collection

Scan here to view the entire *Table Leg Collection* including specifications and line drawings.



Table Legs have become a popular addition for kitchen island construction. **Castlewood's Table Leg Collection** contains a variety of intricate and basic leg designs that are suitable for both kitchen islands and tables. These legs are available in a variety of hardwoods including Birch, Cherry, Maple, Red Oak, and White Oak.



SY-L-5037 SY-L-5039 SY-L-5040 SY-L-5041 SY-L-5052 SY-L-5056 SY-L-5063 SY-L-5064 SY-L-5134 SY-L-5366
 (35-1/4" x 3-1/2" x 3-1/2") (35-1/4" x 3") (34-1/2" x 4") (35-1/4" x 3-1/2") (35-1/4" x 5") (35-1/4" x 3-1/2") (36" x 3-1/2")
 SY-L-5065
 (35-1/4" x 5")



www.castlewood.com Design Enhancements

Onlay Collection

Kitchen and bath design has traditionally employed the use of filler boards to plug the gaps between sets of cabinets and give interior millwork a more built in appearance. **Castlewood's Onlay Collection** provides a decorative half round column solution that will fit nicely on top of plain cabinet fillers and complete the look.



Scan here to view the entire *Onlay Collection* including specifications and line drawings.



SY-P-5031-S



SY-P-5032-S



SY-P-5033-S

(35-1/4" x 3-1/2" x 1-11/16")

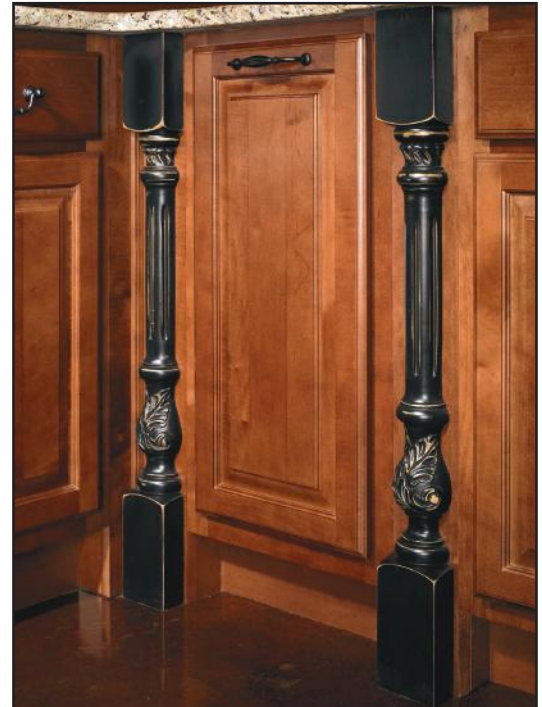

SY-P-5034-S



SY-P-5035-S



SY-P-5036-S

(35-1/4" x 3-1/2" x 1-11/16")



W-T-1570



W-T-1571



W-T-1572



W-T-1573

(96" x 1-1/2" x 23/32")



W-T-2070

(96" x 2" x 23/32")



W-T-1500
(4" x 2-5/8" x 1-1/4")



W-T-1501
(4" x 2-5/8" x 1-1/4")



W-T-1502
(4" x 2-5/8" x 1-1/4")



W-T-1510
(2-1/2" x 2-5/64" x 1")



W-T-1511
(2-1/2" x 1-29/32" x 1")



W-T-1520
(2-1/2" x 1-7/8" x 7/8")



W-T-1521
(2-1/2" x 1-7/8" x 7/8")





Scan here to view the entire *Crown Molding Collection* including specifications and line drawings.



Crown Molding Collection

Castlewood's Crown Molding Collection offers a variety of styles and configurations to accent kitchen cabinets and add a finishing touch to home interiors. These designs are available in a variety of hardwoods including Alder, Cherry, Hickory, Maple, Red Oak, and White Oak.

Moldings are provided in both random and specified lengths.



W-M-258 *Small Crown*

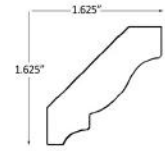

W-M-278 *Small Crown*

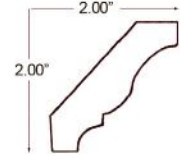

W-M-P2015C *Small Insert Crown*

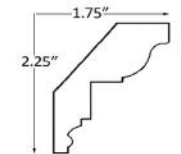

W-M-3C *Decorative Crown*

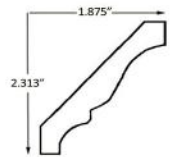

W-M-3COV *Beaded Cove Crown*

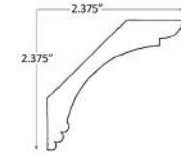

W-M-SC *Shaker Crown (2 piece)*

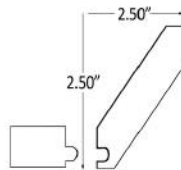

W-M-CMC5 *Cabinet Mount Crown*

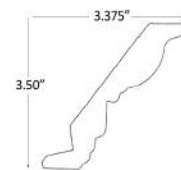

W-M-4C *Traditional Insert Crown*

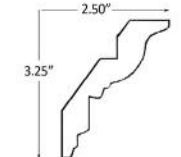

W-M-55COV *Coved Crown*

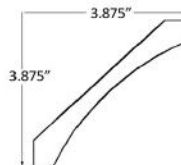

W-M-458 *Traditional Crown*

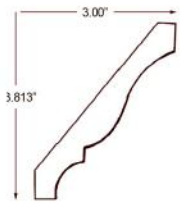

W-M-75C *Large Insert Crown*

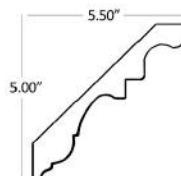

W-M-725C *Jumbo Crown*











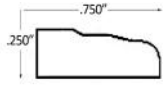



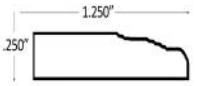



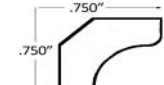



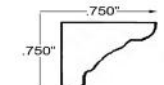

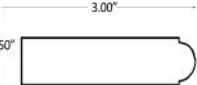





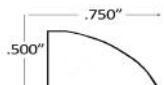
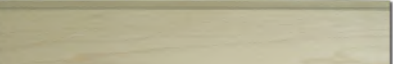
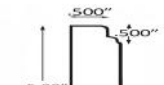

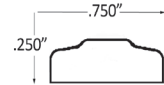



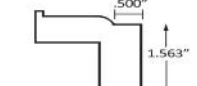



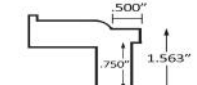

Cabinet Trim Collection

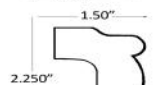
Castlewood's Cabinet Trim Collection offers a variety of styles and configurations to accent kitchen and bath cabinets. These designs are available in a variety of hardwoods including Alder, Cherry, Hickory, Maple, Red Oak, and White Oak. Moldings are provided in both random and specified lengths.

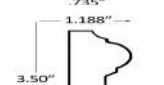

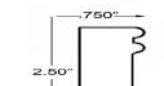
Scan here to view the entire Cabinet Trim Collection including specifications and line drawings.

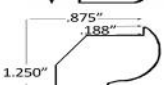
			
W-M-2 Small Scribe		W-M-TBEM Triple Bead	
			
W-M-3 Large Scribe		W-M-ISC135 Inside Corner	
			
W-M-4 Inside Corner		W-M-OC135 Outside Corner	
			
W-M-4TIC Inside Corner		W-M-DEM Decorative Edge	
			
W-M-5L Outside Corner		W-M-FBM Furniture Base	
			
W-M-6 Shoe		W-M-FBM5 Furniture Base	
			
W-M-12-WF Batten		W-M-DBM Decorative Base	
			
W-M-SLR Shaker Light Rail		W-M-BM525 Decorative Base	
			
W-M-SLR-WG Grooved Light Rail		W-M-BBM Big Base	
			
W-M-LR Light Rail		W-M-CR35 Chair Rail	
			
W-M-2711 Light Rail			
			
W-M-UCC Under Cabinet Crown			



Carved Molding Collection

Castlewood's **Carved Molding Collection** offers a distinctive finishing touch for interior millwork applications. These designs are carefully crafted to enhance detail and add depth to home decor. Moldings are available in eight foot sections. Available species include Birch, Cherry, Hickory, Maple and Red Oak.

Scan here to view the entire *Carved Molding Collection* including specifications and line drawings.

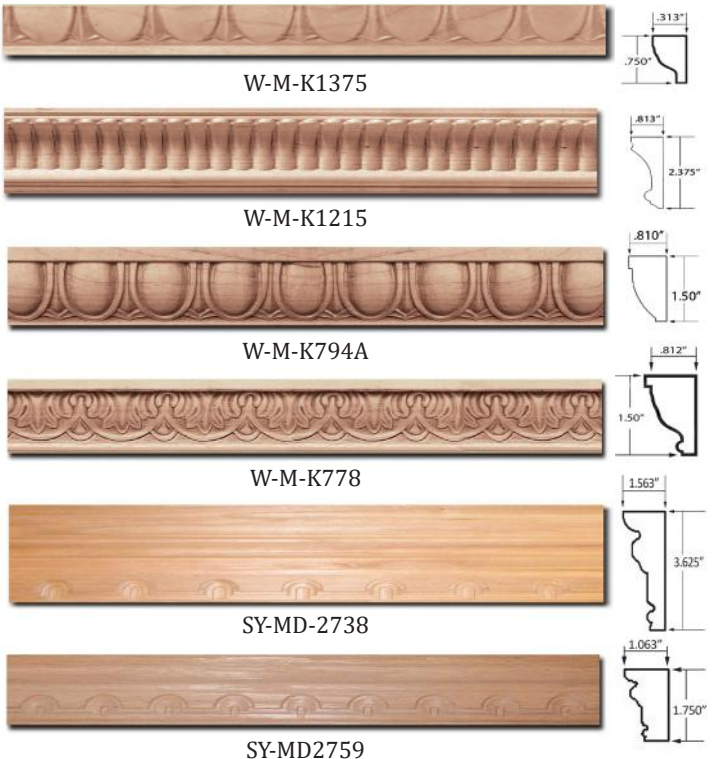
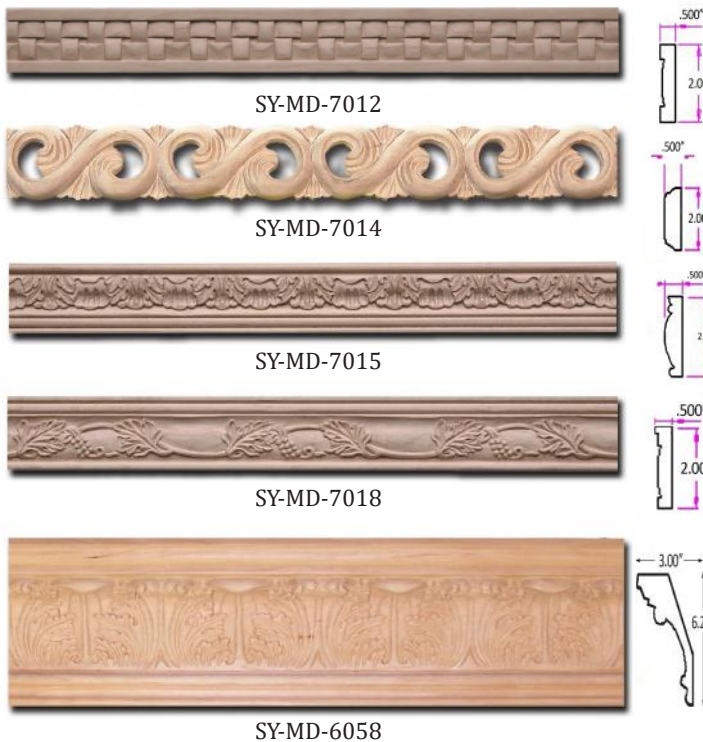
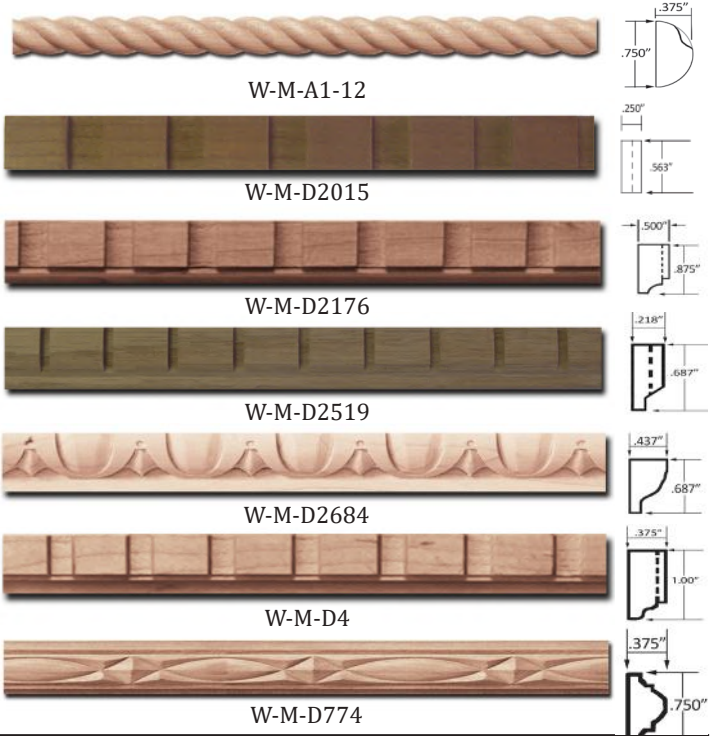

www.castlewood.com

Design Enhancements

Ornament Collection

Castlewood offers **Hand Carved Ornaments** in a variety of designs and sizes to enhance and beautify home decor. Some designs are available in multiple sizes. These intricately carved hardwood ornaments are available in a variety of species including Birch, Cherry, Maple and Red Oak.



Scan here to view the entire *Ornament Collection* including specifications and line drawings.



SY-2124
(5-1/2" x 24" x 3/4")



SY-3030
(5-5/8" x 20" x 1")



SY-3038
(5" x 20" x 5/8")



SY-3043
(5-1/2" x 20" x 5/8")



SY-CF-3050
(6-3/8" x 24" x 1-1/2")

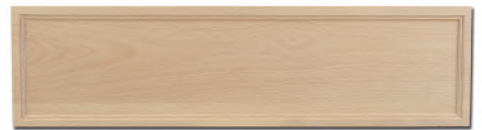

SY-3620
(5" x 20" x 5/8")



SY-O-042 (7-1/2" x 36" x 1")

SY-O-043 (5" x 24" x 3/4")



SY-O-227
(4-1/2" x 20" x 5/8")



SY-O-047 (7-1/2" x 36" x 1")

SY-O-048 (6" x 24" x 3/4")

SY-O-049 (4" x 12" x 5/8")





Rosette Collection

Rosettes are small badges of decoration used to adorn and embellish interior trim. **Castlewood** offers an array of **Hand Carved Rosettes** in various styles and configurations. Most designs are available in two sizes. These finely carved medallions are available in a variety of species including Birch, Cherry, Maple and Red Oak.

Scan here to view the entire *Rosette Collection* including specifications and line drawings.



SY-1001
(5" x 5" x 5/8")
SY-1002
(2-7/8" x 2-7/8" x 1/2")



SY-2101
(2-7/8" x 2-7/8" x 1/2")
SY-2102
(5" x 5" x 5/8")



SY-2252
(2-7/8" x 2-7/8" x 1/2")
SY-2255
(5" x 5" x 3/4")



SY-2253
(2-7/8" x 2-7/8" x 1/2")
SY-2256
(5" x 5" x 3/4")



SY-3034
(5-7/8" x 5-7/8" x 13/16")
SY-3035
(2-7/8" x 2-7/8" x 13/16")



SY-3036
(2-7/8" x 2-7/8" x 1/2")
SY-3037
(5-7/8" x 5-7/8" x 1/2")



SY-3044
(5" x 5" x 7/8")



SY-RS-173
(4-1/2" x 2-3/4" x 5/8")



SY-3630
(2-7/8" x 2-7/8" x 3/4")
SY-3650
(5-7/8" x 5-7/8" x 3/4")



SY-RS-02
(5" x 5" x 5/8")
SY-RS-03
(2-7/8" x 2-7/8" x 7/16")



SY-RS-093
(1-7/8" x 3/8")



SY-RS-250
(2-7/8" x 2-7/8" x 3/8")



W-R-3
(3" x 3" x 3/4")

W-R-6
(6" x 6" x 3/4")



www.castlewood.com

Design Enhancements

Valance Collection

In many kitchen designs a valance is used to fill the space between wall cabinets over a sink base to enhance the finished appearance. Decorative valances are also useful in the composition of mantel range hoods. **Castlewood's Valance Collection** offers several configurations to satisfy these applications.



Scan here to view the entire *Valance Collection* including specifications and line drawings.



SY-VA-6033
(6" x 49" x 1-1/4")



SY-VA-6048
(6" x 49" x 1-1/4")



SY-VA-6051
(9" x 3" in 36" and 48" widths)



SY-VA-6052
(9" x 3/4" in 36" and 48" widths)



SY-AV
(9" x 3/4" in 30", 36", 42", 48", and 54" widths)



SY-PV
(9" x 3/4" in 30", 36", 42", 48", 54" and 60" widths)



SY-TAV
(6-1/2" x 3/4" in 30", 36", 42", 48", 54" and 60" widths)



SY-SLV
(9" x 5/8" in 30", 36", 42", 48", 54" and 60" widths)

www.castlewood.com

Design Enhancements





Wine Storage

Scan here to view the Wine Storage Collection including specifications and line drawings.



Castlewood provides a variety of wine storage solutions for use around wet bars and in kitchens. **Wine Rack Lattice** panels are produced in *Traditional Plain S4S*, and *Shaker* styles. These designs as well as, a *Contemporary "X"* configuration are available in Alder, Cherry, Hickory, Maple and Red Oak.

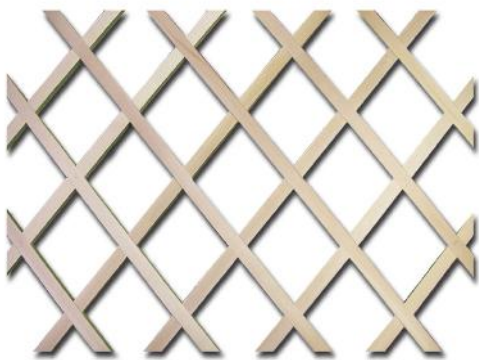

W-WR Traditional Wine Lattice

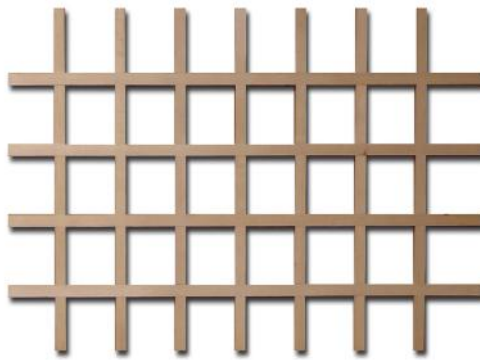

W-WR-SK Shaker Wine Lattice



W-WR-X Contemporary Wine Rack

Wine Lattice panels are available in a variety of standard sizes including 12x34-1/2, 17x29, 19x32, 19x38, 23x29, 25x32, 25x45, 30x60 and 36x36. Custom sizes are available by request. Standard bottle opening is 4-1/4" x 4-1/4".

The Contemporary styled "X" Wine Rack is supplied KD, ready to finish and assemble. The standard size is 22" x 22". Custom sizes are available by request.



Stemware Rack

Store and display your *Wine Glasses* and *Champagne Flutes* with **Castlewood's Stemware Rack Assemblies**. These storage racks are made of solid hardwoods and come in a variety of standard sizes. Custom configurations are available by request. Standard species include Alder, Cherry, Hickory, Maple and Red Oak.

Castlewood®



Scan here to view the *Stemware Rack Collection* including specifications and line drawings.



W-JSSA Stemware Shelf Assembly



W-SR Stemware Rack



W-SR Stemware Rack (edge view)

Stemware Shelf Assemblies are available in 24", 30", 36", 42" and 38" widths. *Stemware Rack* units are available standard in 18", 24", 30", and 36". Alternative widths are also available as special order. All Stemware Racks and Shelf Assemblies are made of solid North American Hardwood.



Island End Panel Assemblies

Scan here to view the *Island End Panel Collection* including specifications and line drawings.



Castlewood can help your island dreams come true with our finely crafted **Island End Panel Assemblies**. These units are sold fully assembled, ready to finish and install. Styles include Acanthus, French, Mission and Reed. Standard available species include Cherry, Maple and Red Oak.



SY-JIEFP
French Island End Panel
(35-1/4" x 24" x 3-1/2")



SY-JIEMP
Mission Island End Panel
(35-1/4" x 24" x 3-1/2")



SY-JIEAP
Acanthus Island End Panel
(35-1/4" x 24" x 3-1/2")



SY-JIERP
Reeded Island End Panel
(35-1/4" x 24" x 3-1/2")

Island End Panel Assemblies are constructed using the finest North American Hardwoods. Posts are joined with an apron formed by a pair of 3/4" thick lumber stretchers using pocket screws. Custom widths are available upon request.



X-Island End Panels

Compliment your Island pleasure with **Castlewood's X-Island End Panels**. These units are provided in two sections, an island end filler panel and a framed X overlay. They can be purchased together or separately and species can be mixed and matched to design a custom look.



Scan here to view the *X-Island End Panel Collection* specifications.



SY-JXIF
X-Island Overlay



SY-JPIE Plain Island
End Filler Panel



SY-JPIE and SY-JXIF
together

Castlewood X-Island End Panels are built using high quality North American Hardwood and Plywood. The X-Panel component is a 3/4" thick overlay made entirely of hardwood lumber. The Plain Island Filler Panel is made of hardwood plywood and comes with 3/4" thick hardwood filler strips on each end.

Standard available height is 34-1/2". Available lengths are 24", 30", 36", and 48". Plain Island End Filler Panels come in three standard widths, 3", 6", and 12". Available species include Alder, Cherry, Hickory, Maple, Red Oak, and White Oak. X-Island Overlays are also available in six prefinished rustic spruce colors, Black, Brown, Dark Gray, Light Gray, White, and Whitewash. (matching Rustic Plain Island End Filler Panels are not available).



Vanity Base Assemblies

Turn a traditional bathroom vanity cabinet into a free standing piece of fine furniture with one of **Castlewood's Vanity Base Assemblies**. These units are sold fully assembled and ready to finish. Standard available species include Cherry, Maple and Red Oak.

Scan here to view the *Vanity Base Collection* including specifications and line drawings.



SY-VBAQ
Queen Anne Vanity Base Assembly



SY-VBAC
Coved Vanity Base Assembly



SY-VBAS
Shaker Vanity Base Assembly



SY-VBAA
Acanthus Vanity Base Assembly



Vanity Base Assemblies are constructed using the finest North American Hardwoods.

Frames are mitered and Bun Feet are secured with screws.

Standard base dimensions are 31-1/2" (w) x 21-3/4" (d) and 37-1/2" (w) x 21-3/4" (d). All units are 5-1/4" tall.

Alternative versions are available using any of the *Decorative Bun Feet* found within this catalog.



Vanities and Island Bases

Castlewood produces fully assembled ***Vanities and Island Bases*** with a variety of leg and shelving options. These fully assembled units are hand sanded and ready to finish. Standard available species include Alder, Cherry, Hickory, Maple and Red Oak.



Scan here to view the *Vanity Collection* including specifications and line drawings.



SY-VTL
Tapered Vanity



SY-VSK
Shaker Vanity

Castlewood introduces ***Vanity and Island Bases***. These high quality units are built using North American Hardwoods. Units come pre-assembled with one or two plain or ventilated shelves.

Various alternate designs are available using any of the ***Table Legs*** and ***Island Posts*** found within this catalog. Heights, widths and depths are customizable to fit island or vanity applications. Typical island heights are 35-1/4". Typical vanity heights are 30" and 34-1/2". Widths are typically 24", 30" and 36". Depths are typically 21", 24", 30" and 36". Custom sizes are available by request.



Drawer Sides

Scan here to view the *Drawer Side Collection* including specifications and line drawings.



Castlewood offers **Birch Plywood Drawer Side Blanks** for kitchen, bath and furniture applications. These drawer side blanks have a tough clear UV finish and are CARB 2 certified. The larger widths are suitable for use as shelving. Solid Birch and Poplar drawer components are also available within our dedicated container programs.



MSC-PDS Plywood Drawer Side Blank

Drawer Side and Shelving Blanks are constructed of pre-finished 9 ply Birch plywood. The material is 1/2" thick and is edgebanded along the top edge. The blanks are grooved on one side to accept up to a 5.2mm thick drawer bottom and are clear UV coated. All blanks come standard in 96" lengths. Standard drawer heights are 2", 4", 6", 8", 10" and 12". Other drawer heights are available upon request.



www.castlewood.com

Design Enhancements

Removable Upper Access



A Removable Upper Access option has been developed for municipal building codes that require full inspection of ducting and wiring. This option also makes installation of the ventilation system easier. The removable upper access is available on all configurations. On Chimney style hoods the entire upper section will detach. On Shiplap Models a section of planks on the front portion of the hood is made removable.



SY-WCH-36-M-D
(Upper Section)



SY-WCVH-36-KA-D
(Upper Section)



SY-WCH-36-M-D
(Lower Section)



SY-WCVH-36-KA-D
(Lower Section)





Range Hood Trim Options

Scan here to view the Range hood Trim options for select chimney style range hoods.



Castlewood now offers several molding options on select chimney style range hoods. **Decorative, Plain, and No Trim** are the most commonly chosen options. A selection of **carved moldings** can also be added to give an even more custom appearance. **Carved Moldings** can be found on page 50 of this catalog.



Decorative Trim (Standard)



Plain Trim on Shiplap Chimney (Standard)



Plain Trim on Traditional Chimney (-PT)



No Trim on Traditional Chimney (-NT)

Range Hood Custom Molding Chart			
Model #	Decorative	Plain	No Molding
SY-WCH	X (standard)	X	X (non detachable)
SY-WCHH	X (standard)	X	X (non detachable)
SY-WCVS	X (standard)	X	X (non detachable)
SY-WCVH	X (standard)	X	X (non detachable)
SY-WCVA	X (standard)	X	X (non detachable)
SY-WCVX	X (standard)	X	X (non detachable)
SY-WCSL		X (standard)	X
SY-WCSLR		X (standard)	X
SY-WCSLXXL		X (standard)	X
SY-WCSXLR		X (standard)	X
SY-WCVHSL	X (standard)	X	X
SY-WCVHSLR		X (standard)	X
SY-WCNOSL		X (standard)	X (non detachable)



No Trim on Shiplap Chimney (-NT)

Some limitations apply. The No Trim (-NT) option eliminates the possibility of the chimney hood having removable access. Orders placed without a designation will receive the standard trim.



Application Gallery





QUICK SHIP PROGRAM

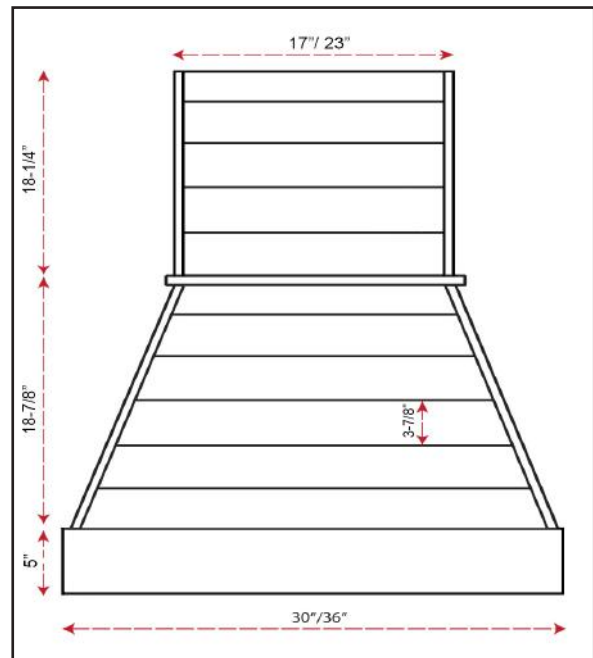
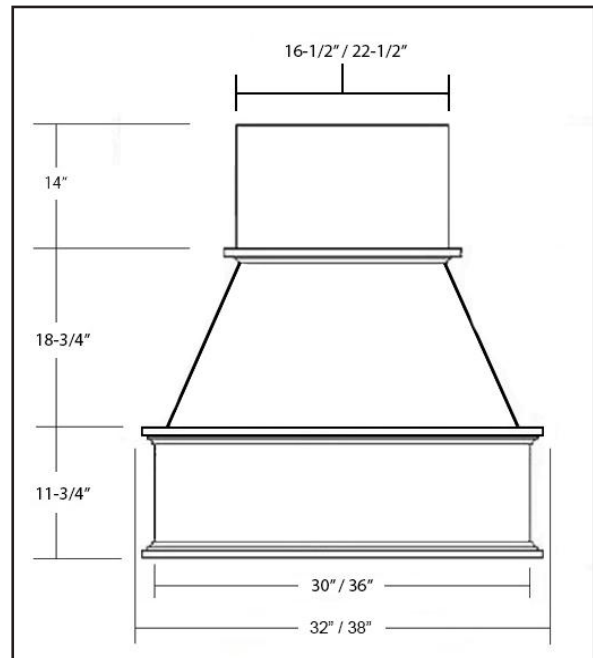

All products in the Castlewood Quick Program ship within 2 days from stock. Chimney Hoods are made from Hardwood Lumber and MDF. All units are already primed and ready to finish. The Shiplap Chimney Hood will be available both RTA and fully assembled.

Available accessories include:

Ascension 350, 500, and 620 CFM Ventilators, Broan 300, 400, and 600 CFM Ventilators, Powder Coated and Stainless Steel Liners, Recirculation Kits, Charcoal and Hybrid Baffle Filters



QUICK SHIP PROGRAM

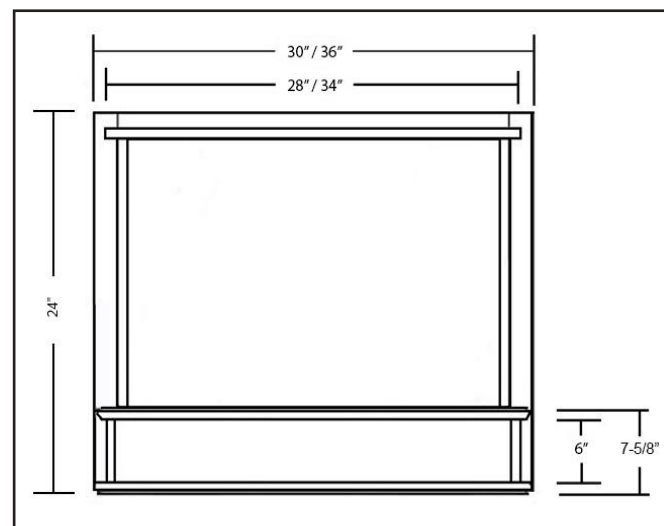
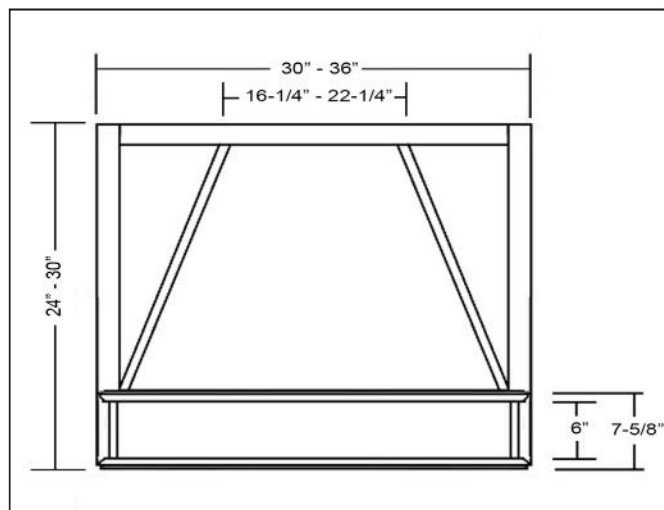

Range Hood Fronts

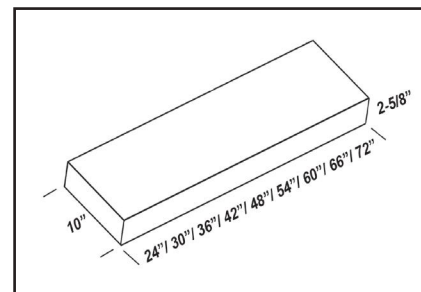

Floating Shelves

SY-JMSP24-IM, SY-JMSP30-IM, SY-JMSP36-IM, SY-JMSP42-IM, SY-JMSP48-IM, SY-JMSP54-IM, SY-JMSP60-IM, SY-JMSP66-IM, SY-JMSP72-IM

All products in the Castlewood Quick Program ship within 2 days from stock.
 Range Hood Fronts and Floating Shelves are made from Hardwood Lumber and MDF.
 All units are already primed and ready to finish.

Castlewood®

Design Enhancements

2020™
ACCREDITED
MANUFACTURER



Castlewood.com